

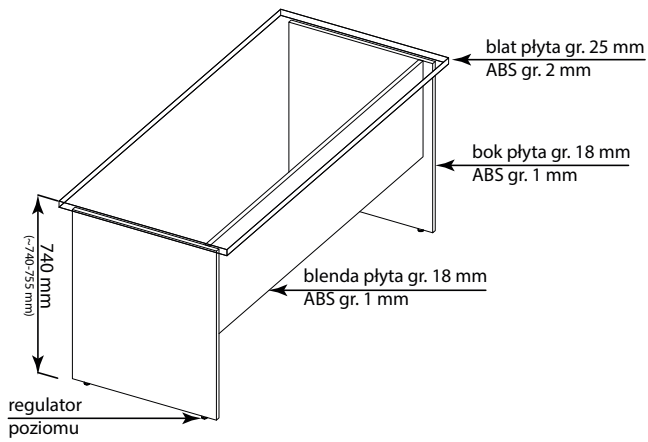

HEBE

biurka proste typu BP



biurka proste typu BE

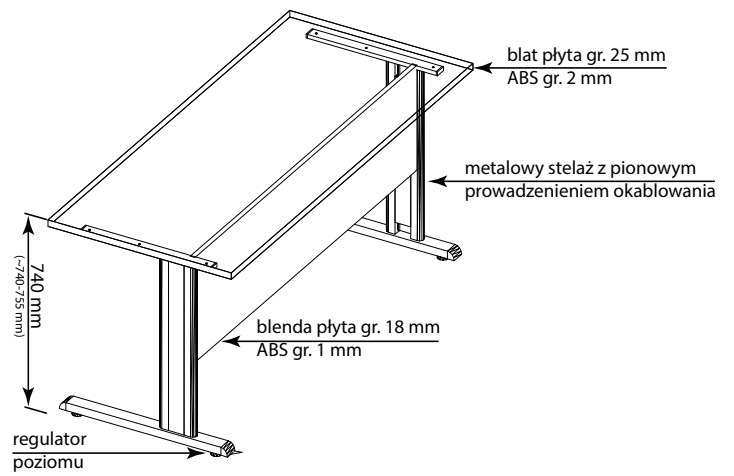

biurka proste typu BO

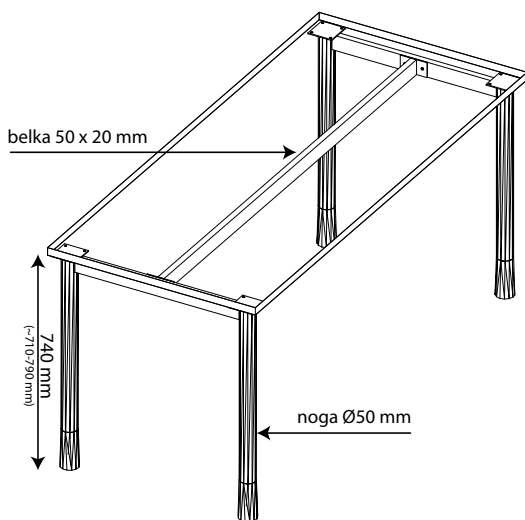

biurka proste typu BK

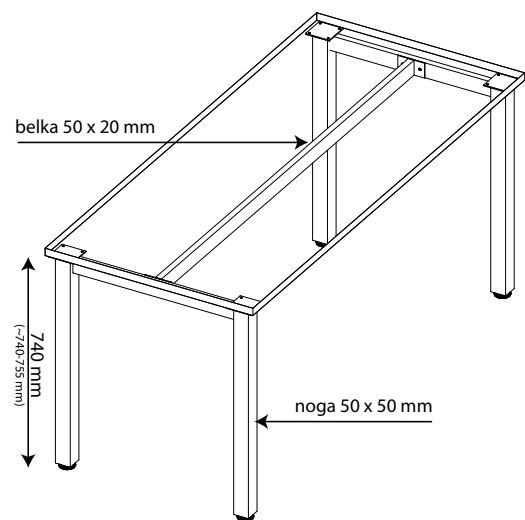

OPIS BIUREK I STOŁÓW

stół konferencyjny typu BO

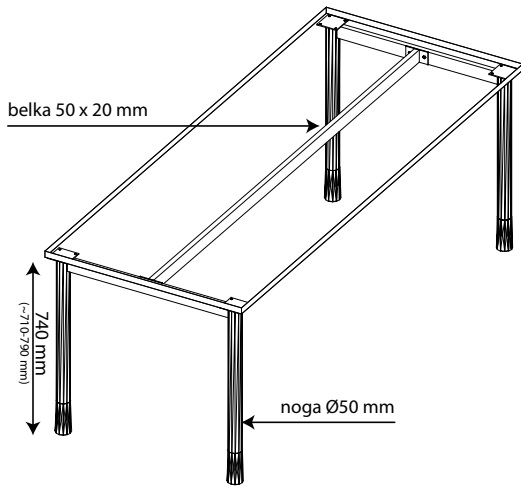

stół konferencyjny typu BK

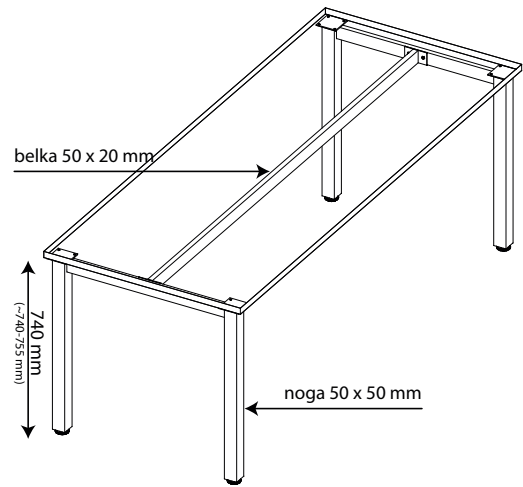

stół z nogą środkową do dwóch ram

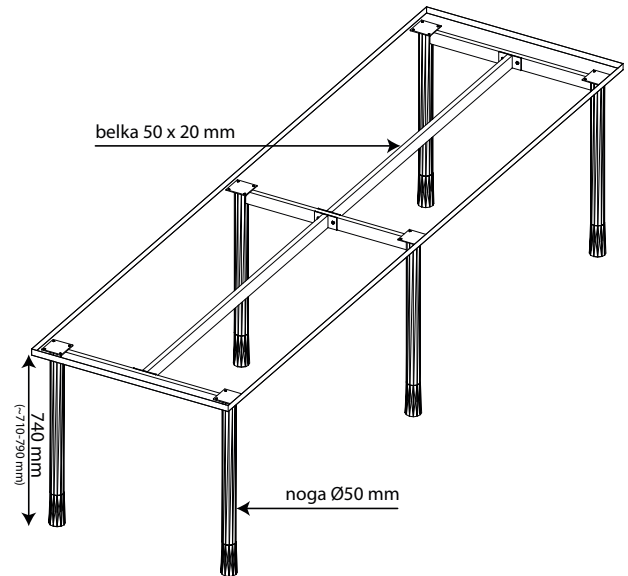
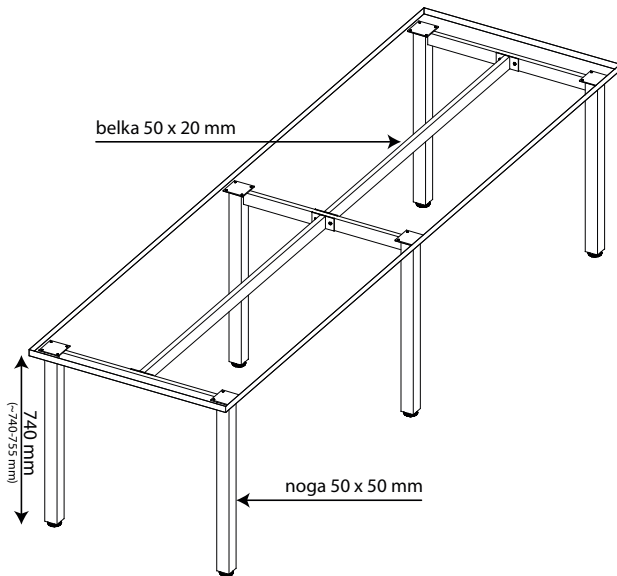

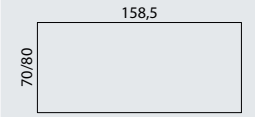
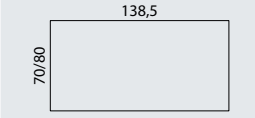
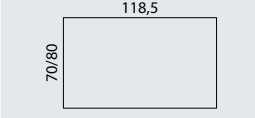
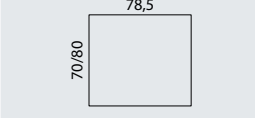
		BP		BO FI 50		BE		BK 50X50	
 <p>178,5 70/80</p>	178,5x70x74h	BP00/7	521 zł	BO00/7	749 zł	BE00/7	787 zł	BK00/7	904 zł
	178,5x80x74h	BP00/8	568 zł	BO00/8	781 zł	BE00/8	814 zł	BK00/8	942 zł
 <p>158,5 70/80</p>	158,5x70x74h	BP01/7	487 zł	BO01/7	727 zł	BE01/7	756 zł	BK01/7	881 zł
	158,5x80x74h	BP01/8	529 zł	BO01/8	756 zł	BE01/8	781 zł	BK01/8	915 zł
 <p>138,5 70/80</p>	138,5x70x74h	BP02/7	452 zł	BO02/7	704 zł	BE02/7	724 zł	BK02/7	860 zł
	138,5x80x74h	BP02/8	491 zł	BO02/8	730 zł	BE02/8	745 zł	BK02/8	890 zł
 <p>118,5 70/80</p>	118,5x70x74h	BP03/7	432 zł	BO03/7	664 zł	BE03/7	692 zł	BK03/7	818 zł
	118,5x80x74h	BP03/8	458 zł	BO03/8	688 zł	BE03/8	710 zł	BK03/8	847 zł
 <p>78,5 70/80</p>	78,5x70x74h	BP04/7	360 zł	BO04/7	618 zł	BE04/7	627 zł	BK04/7	773 zł
	78,5x80x74h	BP04/8	380 zł	BO04/8	636 zł	BE04/8	641 zł	BK04/8	796 zł

BIURKA REGULOWANE ELEKTRYCZNIE POJEDYNCZE (regulacja w zakresie 65-130h)

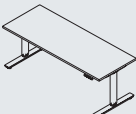
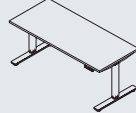
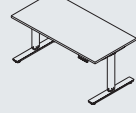
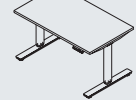
	178,5x80	BR00/8	2 635 zł
	158,5x80	BR01/8	2 613 zł
	138,5x80	BR02/8	2 591 zł
	118,5x80	BR03/8	2 568 zł

BIURKA REGULOWANE ELEKTRYCZNIE PODWÓJNE (regulacja w zakresie 65-130 h)

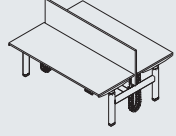
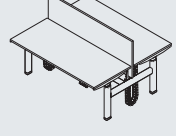
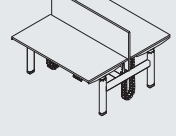
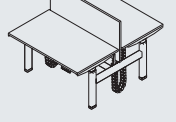
	178,5x166,5x65-130h	BRD00/8	5 026 zł
	Przegroda płytowa		369 zł
	158,5x166,5x65-130h	BRD01/8	4 981 zł
	Przegroda płytowa		330 zł
	138,5x166,5x65-130h	BRD02/8	4 937 zł
	Przegroda płytowa		294 zł
	118,5x166,5x65-130h	BRD03/8	4 892 zł
	Przegroda płytowa		258 zł

BIURKA PROFILOWANE		BP	BO FI 50	BE	BK 50X50
158,5/45x90/70x74h 158,5/45x100/80x74h	BP05/7 627 zł BP05/8 668 zł	BO05/7 864 zł BO05/8 893 zł	BE05/7 878 zł BE05/8 903 zł	BK05/7 1 002 zł BK05/8 1 035 zł	
158,5/45x90/70x74h 158,5/45x100/80x74h	BP06/7 627 zł BP06/8 668 zł	BO06/7 864 zł BO06/8 893 zł	BE06/7 878 zł BE06/8 903 zł	BK06/7 1 002 zł BK06/8 1 035 zł	
138,5/45x100/70x74h 138,5/45x110/80x74h	BP07/7 609 zł BP07/8 647 zł	BO07/7 850 zł BO07/8 875 zł	BE07/7 862 zł BE07/8 883 zł	BK07/7 994 zł BK07/8 1025 zł	
138,5/45x100/70x74h 138,5/45x110/80x74h	BP08/7 609 zł BP08/8 647 zł	BO08/7 850 zł BO08/8 875 zł	BE08/7 862 zł BE08/8 883 zł	BK08/7 994 zł BK08/8 1 025 zł	
158,5/45x100/70x74h 158,5/45x110/80x74h	BP09/7 653 zł BP09/8 695 zł	BO09/7 885 zł BO09/8 908 zł	BE09/7 903 zł BE09/8 926 zł	BK09/7 1 026 zł BK09/8 1 060 zł	
158,5/45x100/70x74h 158,5/45x110/80x74h	BP10/7 653 zł BP10/8 695 zł	BO10/7 885 zł BO10/8 908 zł	BE10/7 903 zł BE10/8 926 zł	BK10/7 1 026 zł BK10/8 1 060 zł	

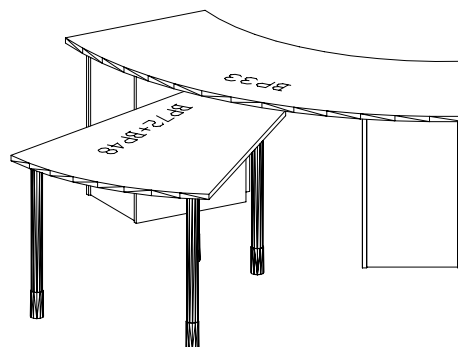
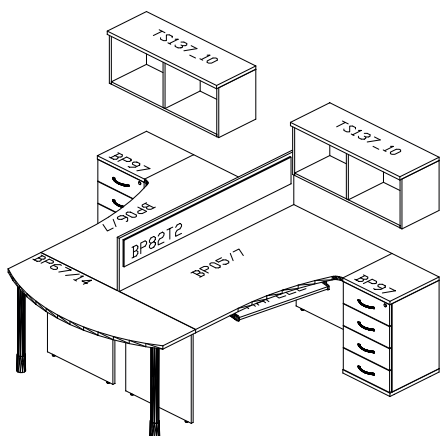















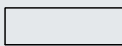

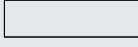

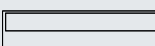
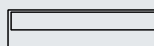

BIURKA SZAFKOWE

	BP21/7 778 zł	BP22/7 778 zł	BP23/7 1 006 zł	BP24/7 1 006 zł	BP25/7 1 178 zł
	BP21/8 832 zł	BP22/8 832 zł	BP23/8 1 047 zł	BP24/8 1 047 zł	BP25/8 1 232 zł
	BP26/7 1 178 zł	BP27/7 1 263 zł	BP28/7 1 263 zł	BP29/7 1 258 zł	BP30/7 1 258 zł
	BP26/8 1 232 zł	BP27/8 1 308 zł	BP28/8 1 308 zł	BP29/8 1 307 zł	BP30/8 1 307 zł
	BP31/7 457 zł	BP32/7 457 zł	BP33/7 1 562 zł	BP34/7 1 562 zł	
	BP31/8 498 zł	BP32/8 498 zł	BP33/8 1 691 zł	BP34/8 1 691 zł	

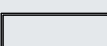



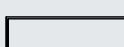
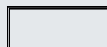
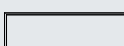

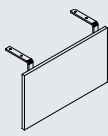
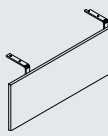
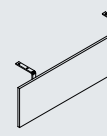
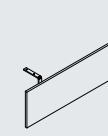
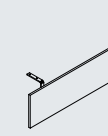
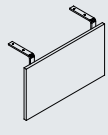
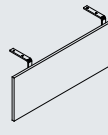
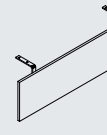
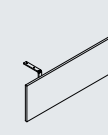
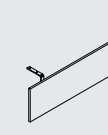

STOŁY KONFERENCYJNE, ŁĄCZNIKI, STOLIKI OKOLICZNOŚCIOWE

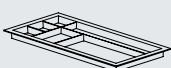
	BP11 496 zł	BP12 608 zł	BP13 730 zł	BP14 680 zł	BP15 644 zł
fi 50	BO11 730 zł	BO12 825 zł	BO13 1 301 zł	BO14 956 zł	BO15 1 496 zł
kwadrat 50x50	BK11 890 zł	BK12 967 zł	BK13 1 483 zł	BK14 1 098 zł	BK15 1 680 zł
Do danej wartości należy doliczyć opłatę za nogę: BP48, BP49.					
	BP16 297 zł	BP17 343 zł	BP18 364 zł	BP19 216 zł	BP20 252 zł
wysokość stolika 50 cm	BS01 312 zł	BS02 510 zł	BS03 526 zł	BS05 491 zł	BS06 460 zł
wysokość stolika 74 cm	BS01W 326 zł	BS02W 521 zł	BS03W 539 zł	BS05W 503 zł	BS06W 473 zł
	BS04/6 725 zł	BS04/7 786 zł	BS04/8 811 zł	BS09/K 1 715 zł	BS09/O 1 837 zł

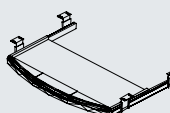
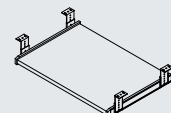
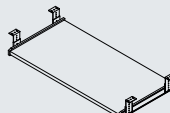
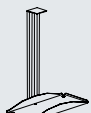
wymiar	plyta laminowana	plyta laminowana jednostronnie tapicerowana	plyta laminowana dwustronnie tapicerowana
PRZEGRODY DO BIUREK			
78,5x55/40	 BP76 220 zł	 BP76T1 306 zł	 BP76T2 395 zł
118,5x55/40	 BP77 267 zł	 BP77T1 422 zł	 BP77T2 533 zł
138,5x55/40	 BP78 268 zł	 BP78T1 409 zł	 BP78T2 552 zł
158,5x55/40	 BP79 283 zł	 BP79T1 434 zł	 BP79T2 575 zł
178,5x55/40	 BP80 298 zł	 BP80T1 458 zł	 BP80T2 608 zł

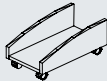
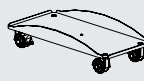
wymiar	wysokość 50 cm	wysokość 70 cm
PINBOARDY (PANELE ŚCIENNE TAPICEROWANE)		
szerokość 78,5	 BP81/8 302 zł	 BP82/8 384 zł
szerokość 118,5	 BP81/12 382 zł	 BP82/12 484 zł
szerokość 138,5	 BP81/14 426 zł	 BP82/14 539 zł
szerokość 158,5	 BP81/16 461 zł	 BP82/16 603 zł
szerokość 178,5	 BP81/18 498 zł	 BP82/18 652 zł

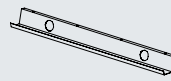
	do biurka L78,5	do biurka L118,5	do biurka L138,5	do biurka L158,5	do biurka L178,5
OŚLONY DO BIUREK					
plyty laminowane	 BP35 213 zł	 BP36 228 zł	 BP37 236 zł	 BP38 244 zł	 BP38/18 253 zł
akryl połysk	 BP39 304 zł	 BP40 376 zł	 BP41 405 zł	 BP42 442 zł	 BP42/18 478 zł

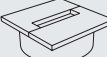
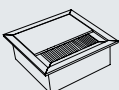
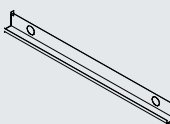





ELEMENTY UZUPEŁNIAJĄCE							
wkładka (piórnik)	noga fi50	noga 50x50	szuflada plastikowa	szuflada L50	szuflada L70	wózek podwieszany 21x48x62H	
 BP46 51 zł	 BP48 100 zł	 BP49 142 zł	 BP51 70 zł	 BP52H 93 zł	 BP53H 107 zł	 BP54 276 zł	
przelotka okrągła fi 60	wózek z płyty 26x45x20,5H	wózek metalowy 21x48x12H	przelotka na papier	kanał podwieszany 105x9,5x8H	zaokrąglenie blatu	osłona kabla pionow	
 BP55 13 zł	 BP56 131 zł	 BP57 197 zł	 BP58 75 zł	 BP59 163 zł	 BP60 25 zł	 OK 176 zł	
przelotka okrągła fi 80	przepust meblowy	kanał skręcany tylko do biurka BE					
 PK 38 zł	 SP66 56 zł	 BP59/08 152 zł BP59/12 184 zł BP59/14 201 zł BP59/16 231 zł BP59/18 242 zł					

RYСУNEK	INDEX	CENA NETTO
ŁĄCZNIKI DO BIUREK – do danej wartości należy doliczyć opłatę za nogę: BP48, BP49.		
	BP61/7	240 zł
	BP61/8	276 zł
	BP62/7	203 zł
	BP62/8	228 zł
	BP63/7	193 zł
	BP63/8	202 zł
	BP64/7	193 zł
	BP64/8	202 zł
	BP65/7	186 zł
	BP65/8	188 zł
	BP66/14	236 zł
	BP66/16	255 zł
	BP67/14	242 zł
	BP67/16	258 zł

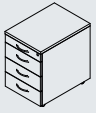
NADSTAWKI			
	30x30x15	BP83	99 zł
	78,5x30x40	BP84/08	220 zł
	88,5x30x40	BP84/09	231 zł
	118,5x30x40	BP84/12	261 zł
	138,5x30x40	BP84/14	286 zł
	158,5x30x40	BP84/16	304 zł
	178,5x30x40	BP84/18	326 zł

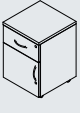

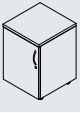
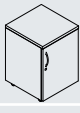



RYСУNEK	INDEX	CENA NETTO	
NADSTAWKI RECEPCYJNE wys. 115 cm, szer. 70cm			
	BP86	889 zł	
	BP87	1 100 zł	
	78,5x30x110	BP85/8	286 zł
	118,5x30x110	BP85/12	362 zł
	138,5x30x110	BP85/14	403 zł
	158,5x30x110	BP85/16	439 zł
	178,5x30x110	BP85/18	476 zł

RYСУNEK	INDEX	CENA NETTO
ŁĄCZNIKI DO BIUREK – do danej wartości należy doliczyć opłatę za nogę: BP48, BP49.		
	BP68/08	226 zł
	BP68/12	233 zł
	BP68/14	260 zł
	BP68/16	271 zł
	BP68/18	282 zł
	BP69/7	246 zł
	BP69/8	250 zł
	BP70/7	271 zł
	BP70/8	250 zł
	BP71	271 zł
	BP72	325 zł
	BP73	308 zł
	BP74	308 zł

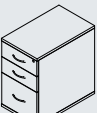
RYSUNEK	WYMIARY SZER./GŁ./WYS.	INDEX	CENA NETTO
KONTENERY NA KÓŁKACH			
	43,2x45x61	BP89	557 zł
		BP89T*	838 zł
	43,2x60x61	BP90	680 zł
		BP90T*	981 zł
		BP90M*	1325 zł
		BP91	680 zł
	43,2x60x61	BP91T*	759 zł
		BP91M*	1325 zł
	43,2x45x61	BP92L	456 zł
		BP92LT*	548 zł
	43,2x45x61	BP92P	456 zł
		BP92PT*	548 zł
	43,2x45x61	BP93L	417 zł
	43,2x45x61	BP93P	417 zł
	43,2x45x61	BP94	548 zł
		BP94T*	731 zł

szuflada dolna na teczki
zawieszane



Uwaga! Szuflady z cichym domykiem za dodatkową dopłatą.



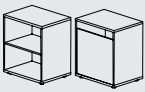
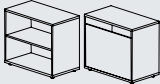
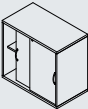
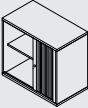
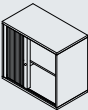

RYSUNEK	WYMIARY SZER./GŁ./WYS.	INDEX	CENA NETTO
KONTENERY O WYSOKOŚCI BIUREK			
	43,2x70x74	BP95/7	772 zł
		BP95/7T*	1 150 zł
		BP95/7M*	1 469 zł
	43,2x80x74	BP95/8	792 zł
		BP95/8T*	1 178 zł
		BP95/8M*	1 493 zł
	43,2x70x74	BP96/7	772 zł
		BP96/7T*	1 032 zł
		BP96/7M*	1 469 zł
	43,2x80x74	BP96/8	792 zł
		BP96/8T*	1 048 zł
		BP96/8M*	1 503 zł
	43,2x45x74	BP97	666 zł
		BP97T*	1 043 zł
	50,2x45x74	BP99	570 zł
		BP99T*	757 zł
	50,2x45x74	BP100	609 zł
		BP100T*	772 zł
	60x45x74	BP101P	747 zł
		BP101PT*	1 034 zł
	60x45x74	BP101L	747 zł
		BP101LT*	1 034 zł

szuflada dolna na
teczki zawieszane

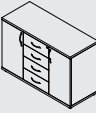
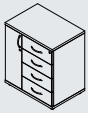
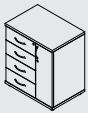
* M – szuflada metalowa perforowana

*T - szuflady na prowadnicach typu Tandem

RYСУNEK	WYMIARY SZER./GŁ./WYS.	INDEX	CENA NETTO
SZAFKI DOSTAWNE DO BIUREK (plecy z płyty)			
	60,2x45x74	BP102	362 zł
	80,2x45x74	BP103	412 zł
	80,2x45x74	BP104/08	716 zł
	100,2x45x74	BP104/10	843 zł
	120,2x45x74	BP104/12	917 zł
	80,2x45x74	BP105/08	1 248 zł
	100,2x45x74	BP105/10	1 340 zł
	120,2x45x74	BP105/12	1 415 zł
	80,2x45x74	BP106/08	1 248 zł
	100,2x45x74	BP106/10	1 340 zł
	120,2x45x74	BP106/12	1 415 zł
	80,2x60x60	BP107	693 zł
	80,2x60x60	BP108	743 zł
		BP109	1 047 zł
		BP109T*	1 375 zł
		BP110	810 zł
		BP110T*	1 175 zł
		BP111	810 zł
		BP111T*	1 175 zł

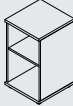
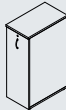
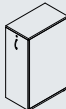
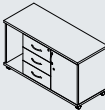
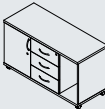
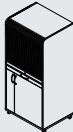

RYСУNEK	WYMIARY SZER./GŁ./WYS.	INDEX	CENA NETTO
SZAFKI DOSTAWNE DO BIUREK (plecy z płyty)			
	80,2x45x74	BP112	641 zł
	60,2x45x74	BP113	586 zł
	43,2x45x74	BP114	379 zł
	43,2x45x74	BP115	379 zł
	43,2x45x74	BP116/4	286 zł
	60,2x45x74	BP116/6	326 zł
	80,2x45x74	BP116/8	391 zł
	40,2x70x114,5	BP117/7	1 795 zł
	40,2x80x114,5	BP117/8	1 831 zł
	40,2x70x114,5	BP118/7	1 795 zł
	40,2x80x114,5	BP118/8	1 831 zł
		BP122	912 zł
		BP122T*	1 219 zł
		BP123	912 zł
		BP123T*	1 219 zł
	74,2x60x165,5	BP124 socjalna	2 669 zł

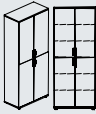
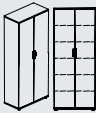
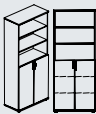
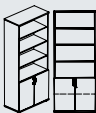
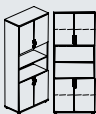
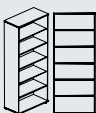
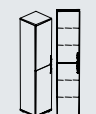
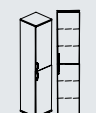
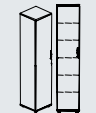
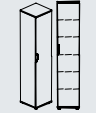
*T - szuflady na prowadnicach typu Tandem

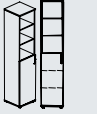
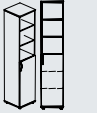
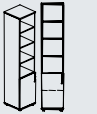
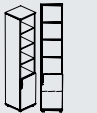
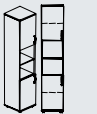
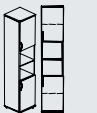
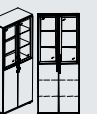
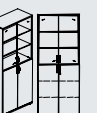
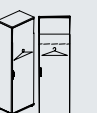
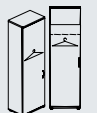
RYСУNEK	WYMIARY SZER./GŁ./WYS.	INDEX	CENA NETTO
SZAFY I REGAŁY wys. 219,5 cm (plecy z HDF)			
	80,2x40x219,5	TS601	1 113 zł
	80,2x40x219,5	TS601/1	1 047 zł
	80,2x40x219,5	TS602	937 zł
	80,2x40x219,5	TS603	899 zł
	80,2x40x219,5	TS604	1 066 zł
	80,2x40x219,5	TS605	629 zł
	40,2x40x219,5	TS606	755 zł
	40,2x40x219,5	TS607	755 zł
	40,2x40x219,5	TS606/1	719 zł
	40,2x40x219,5	TS607/1	719 zł

RYСУNEK	WYMIARY SZER./GŁ./WYS.	INDEX	CENA NETTO
SZAFY I REGAŁY wys. 219,5 cm (plecy z HDF)			
	40,2x40x219,5	TS608	655 zł
	40,2x40x219,5	TS609	655 zł
	40,2x40x219,5	TS610	637 zł
	40,2x40x219,5	TS611	637 zł
	40,2x40x219,5	TS612	716 zł
	40,2x40x219,5	TS618	716 zł
	80,2x40x219,5	TS613*	2 108 zł
	80,2x40x219,5	TS614*	1 654 zł
	60,2x40x219,5	TS615	813 zł
	60,2x40x219,5	TS615L	813 zł

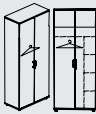
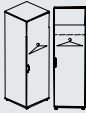
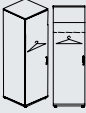
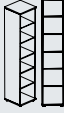
* drzwi szklane bez zamka

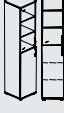
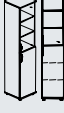
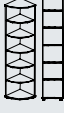
RYСУNEK	WYMIARY SZER./GŁ./WYS.	INDEX	CENA NETTO
SZAFY I REGAŁY wys. 219,5 cm (plecy z HDF)			
	80,2x40x219,5	TS616	1 110 zł
	60,2x60x219,5	TS617	969 zł
	60,2x60x219,5	TS617L	969 zł
	40,2x40x219,5	TS619	558 zł
	40,2x40x219,5	TS620*	1 242 zł
	40,2x40x219,5	TS621*	1 242 zł
	40,2x40x219,5	TS622*	1 008 zł
	40,2x40x219,5	TS623*	1 008 zł
	40,2x40x219,5	TS624	521 zł

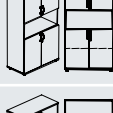
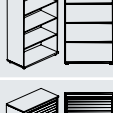
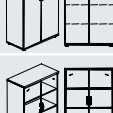
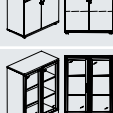
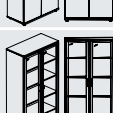
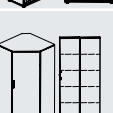
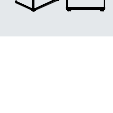
RYСУNEK	WYMIARY SZER./GŁ./WYS.	INDEX	CENA NETTO
SZAFY I REGAŁY wys. 184,1 cm (plecy z HDF)			
	80,2x40x184,1	TS501	904 zł
	80,2x40x184,1	TS502	969 zł
	80,2x40x184,1	TS503	812 zł
	80,2x40x184,1	TS504	775 zł
	80,2x40x184,1	TS505	931 zł
	80,2x40x184,1	TS506	575 zł
	80,2x40x184,1	TS507	1 694 zł
	80,2x40x184,1	TS508*	1 378 zł
	80,2x40x184,1	TS509*	1 506 zł
	80,2x40x184,1	TS510*	1 835 zł
	80,2x40x184,1	TS511*	2 121 zł
	78,1x78,1x184,1	TS512	1 173 zł
	78,1x78,1x184,1	TS512L	1 173 zł
	60,2x40x184,1	TS513	700 zł

* drzwi szklane bez zamka





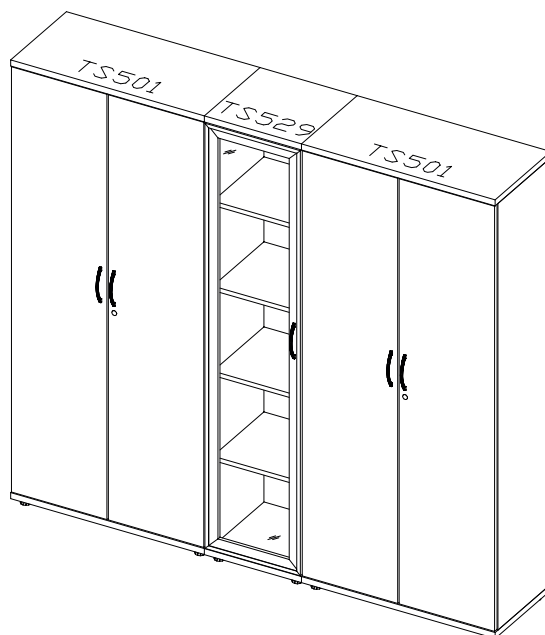

RYСУNEK	WYMIARY SZER./GŁ./WYS.	INDEX	CENA NETTO
SZAFY I REGAŁY wys. 184,1 cm (plecy z HDF)			
	60,2x40x184,1	TS513L	700 zł
	60,2x60x184,1	TS514	800 zł
	60,2x60x184,1	TS514L	800 zł
	80,2x40x184,1	TS515	904 zł
	80,2x60x184,1	TS516	979 zł
	40,2x40x184,1	TS517	596 zł
	40,2x40x184,1	TS518	596 zł
	40,2x40x184,1	TS519	633 zł
	40,2x40x184,1	TS520	633 zł
	40,2x40x184,1	TS521	558 zł
	40,2x40x184,1	TS522	558 zł
	40,2x40x184,1	TS523	540 zł
	40,2x40x184,1	TS524	540 zł
	40,2x40x184,1	TS525	615 zł

RYСУNEK	WYMIARY SZER./GŁ./WYS.	INDEX	CENA NETTO
SZAFY I REGAŁY wys. 184,1 cm (plecy z HDF)			
	40,2x40x184,1	TS526	615 zł
	40,2x40x184,1	TS527	452 zł
	40,2x40x184,1	TS528*	1 267 zł
	40,2x40x184,1	TS529*	1 267 zł
	40,2x40x184,1	TS530*	837 zł
	40,2x40x184,1	TS531*	837 zł
	40,2x40x184,1	TS532*	1 117 zł
	40,2x40x184,1	TS533*	1 117 zł

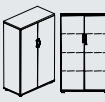
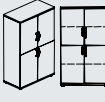
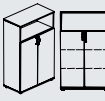
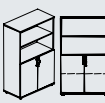
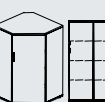
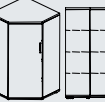
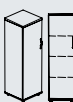
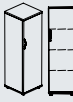

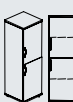

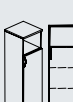

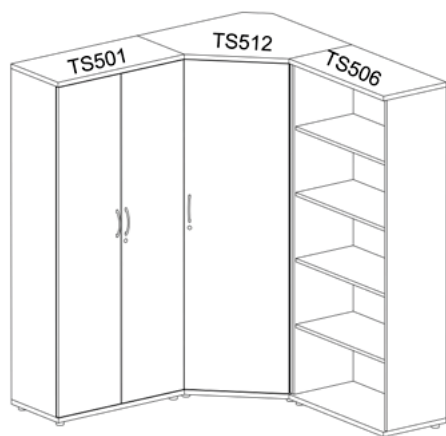

* drzwi szklane bez zamka

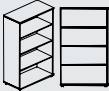
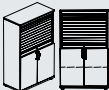
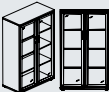
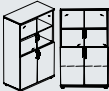
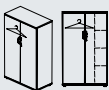
RYSUNEK	WYMIARY SZER./GŁ./WYS.	INDEX	CENA NETTO
SZAFY I REGAŁY wys. 184,1 cm (plecy z HDF)			
	40,2x40x184,1	TS534*	892 zł
	40,2x40x184,1	TS535*	892 zł
	40,2x40x184,1	TS536	466 zł
	40,2x40x184,1	TS537	1 220 zł
	40,2x40x184,1	TS538	1 220 zł
	40,2x40x184,1	TS539	1 248 zł
	40,2x40x184,1	TS540	1 248 zł
	80,2x40x184,1	TS541	2 640 zł
	40,2x40x184,1	TS542	1 155 zł
	80,2x40x184,1	TS543	1 615 zł

RYSUNEK	WYMIARY SZER./GŁ./WYS.	INDEX	CENA NETTO
SZAFY I REGAŁY wys. 148,8 cm (plecy z HDF)			
	80,2x40x148,8	TS401	850 zł
	80,2x40x148,8	TS402	904 zł
	80,2x40x148,8	TS403	786 zł
	80,2x40x148,8	TS404	760 zł
	78,1x78,1x148,8	TS405	1 088 zł
	78,1x78,1x148,8	TS405L	1 088 zł
	40,2x40x148,8	TS406	557 zł
	40,2x40x148,8	TS407	557 zł
	40,2x40x148,8	TS408	587 zł
	40,2x40x148,8	TS409	587 zł
	40,2x40x148,8	TS410	523 zł
	40,2x40x148,8	TS411	523 zł
	40,2x40x148,8	TS412	510 zł







RYСУNEK	WYMIARY SZER./GŁ./WYS.	INDEX	CENA NETTO
SZAFY I REGAŁY wys. 148,8 cm (plecy z HDF)			
	40,2x40x148,8	TS418	510 zł
	80,2x40x148,8	TS413	523 zł
	80,2x40x148,8	TS414	1 516 zł
	80,2x40x148,8	TS415*	2 022 zł
	80,2x40x148,8	TS416*	1 493 zł
	80,2x40x148,8	TS417	852 zł
	40,2x40x148,8	TS419	393 zł
	40,2x40x148,8	TS420*	1 104 zł
	40,2x40x148,8	TS421*	1 104 zł
	40,2x40x148,8	TS422*	774 zł
	40,2x40x148,8	TS423*	774 zł
	40,2x40x148,8	TS424	414 zł
	80,2x40x148,8	TS425	2 359 zł

* drzwi szklane bez zamka

RYСУNEK	WYMIARY SZER./GŁ./WYS.	INDEX	CENA NETTO
SZAFY I REGAŁY wys. 114,5 cm (plecy z HDF)			
	80,2x40x114,5	TS301	653 zł
	80,2x40x114,5	TS302	627 zł
	80,2x40x114,5	TS303*	1 636 zł
	80,2x40x114,5	TS304*	1 175 zł
	40,2x40x114,5	TS305	442 zł
	40,2x40x114,5	TS306	442 zł
	40,2x40x114,5	TS307	430 zł
	40,2x40x114,5	TS308	430 zł
	40,2x40x114,5	TS309*	917 zł
	40,2x40x114,5	TS313*	917 zł
	80,2x40x114,5	TS310	429 zł
	100,2x40x114,5	TS311	1 082 zł
		TS311T*	1 410 zł
	78,1x78,1x114,5	TS312	928 zł
	78,1x78,1x114,5	TS312L	928 zł

*T - szuflady na prowadnicach typu Tandem

Ceny netto, należy doliczyć podatek VAT 23%

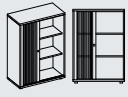
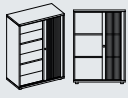
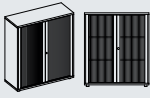
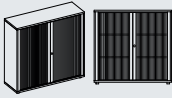
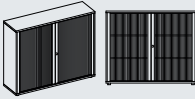



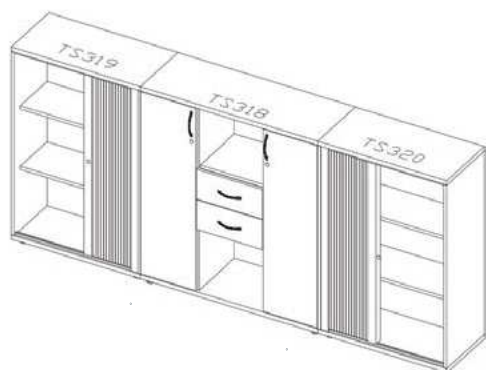

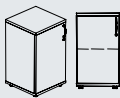
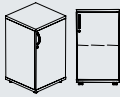
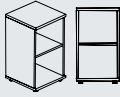
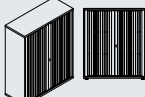
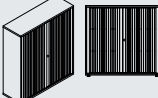
RYСУNEK	WYMIARY SZER./GŁ./WYS.	INDEX	CENA NETTO
SZAFY I REGAŁY wys. 114,5 cm (plecy z HDF)			
	40,2x40x114,5	TS314*	700 zł
	40,2x40x114,5	TS315*	700 zł
	40,2x40x114,5	TS316	300 zł
	40,2x40x114,5	TS317	390 zł
	110,2x40x114,5	TS318	1 086 zł
		TS318T*	1 324 zł
	80,2x40x114,5	TS319	1 489 zł
	80,2x40x114,5	TS320	1 489 zł
	100,2x40x114,5	TS321	1 972 zł
	120,2x40x114,5	TS322	2 197 zł
	140,2x40x114,5	TS323	2 376 zł



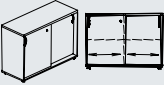
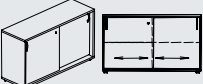
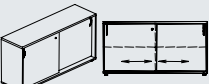
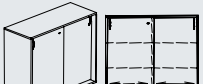
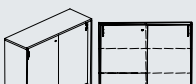
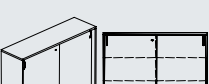



* drzwi szklane bez zamka



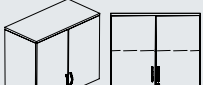
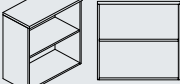

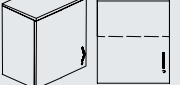
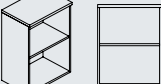
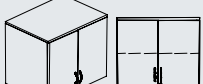
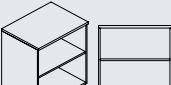
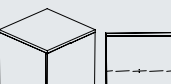
RYСУNEK	WYMIARY SZER./GŁ./WYS.	INDEX	CENA NETTO
SZAFY I REGAŁY wys. 79,2 cm (plecy z HDF)			
	80,2x40x79,2	TS201	551 zł
	80,2x40x79,2	TS202	330 zł
	120,2x40x79,2	TS203	980 zł
		TS203T*	1 308 zł
	78,1x78,1x79,2	TS204	784 zł
	78,1x78,1x79,2	TS204L	784 zł
	40,2x40x79,2	TS205	365 zł
	40,2x40x79,2	TS206	365 zł
	40,2x40x79,2	TS207	255 zł
	80,2x40x79,2	TS208	1 212 zł
	80,2x40x79,2	TS209	1 212 zł
	100,2x40x79,2	TS210	1 554 zł
	120,2x40x79,2	TS211	1 711 zł
	140,2x40x79,2	TS212	1 845 zł



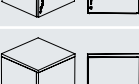

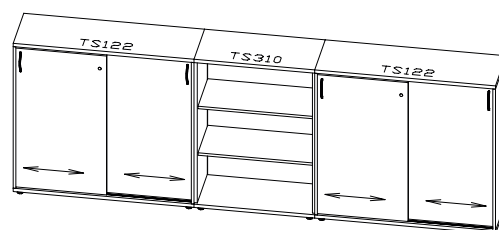
*T - szuflady na prowadnicach typu Tandem

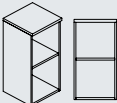
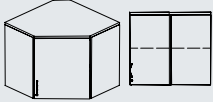
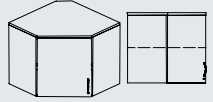
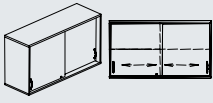
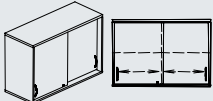
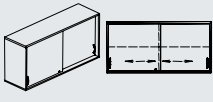
RYСУNEK	WYMIARY SZER./GŁ./WYS.	INDEX	CENA NETTO
SZAFY Z DRZWIAMI SUWANymi (plecy z płyty)			
	100,2x40x79,2	TS112	809 zł
	120,2x40x79,2	TS113	885 zł
	140,2x40x79,2	TS114	962 zł
	100,2x40x114,5	TS121	977 zł
	120,2x40x114,5	TS122	1 077 zł
	140,2x40x114,5	TS123	1 178 zł
	100,2x40x148,8	TS115	1 172 zł
	120,2x40x148,8	TS116	1 294 zł
	140,2x40x148,8	TS117	1 417 zł
	100,2x40x184,1	TS124	1 343 zł
	120,2x40x184,1	TS125	1 488 zł
	140,2x40x184,1	TS126	1 635 zł

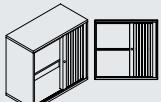
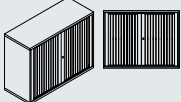
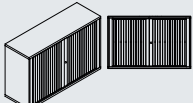
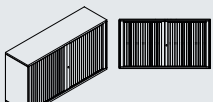
RYСУNEK	WYMIARY SZER./GŁ./WYS.	INDEX	CENA NETTO
NADSTAWKI (plecy z HDF)			
	80,2x40x76	TS127	523 zł
	80,2x40x76	TS1270	298 zł
	60,2x40x76	TS128	404 zł
	60,2x40x76	TS128L	404 zł
	60,2x40x76	TS1280	260 zł
	80,2x60x76	TS129	588 zł
	80,2x60x76	TS1290	379 zł
	60,2x60x76	TS130	484 zł
	60,2x60x76	TS130L	484 zł
	60,2x60x76	TS1300	338 zł
	40,2x40x76	TS132	349 zł
	40,2x40x76	TS133	349 zł

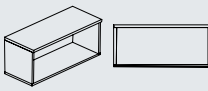
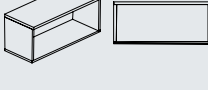

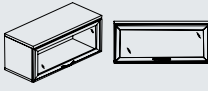
RYSUNEK	WYMIARY SZER./GŁ./WYS.	INDEX	CENA NETTO
NADSTAWKI (plecy z HDF)			
	40,2x40x76	TS1330	246 zł
	78,1x78,1x76	TS134	740 zł
	78,1x78,1x76	TS134L	740 zł
	100,2x40x76	TS131	773 zł
	120,2x40x76	TS135	844 zł
	140,2x40x76	TS136	917 zł
	80,2x40x76	TS141	1 187 zł
	80,2x40x76	TS142	1 187 zł
	100,2x40x76	TS143	1 521 zł
	120,2x40x76	TS144	1 673 zł
	140,2x40x76	TS145	1 806 zł

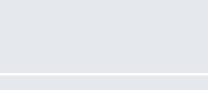
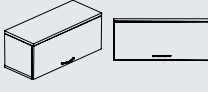
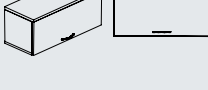
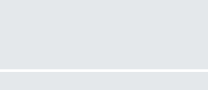
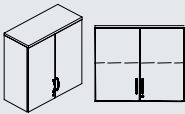
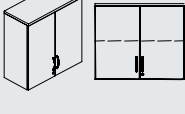
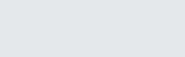
RYSUNEK	WYMIARY SZER./GŁ./WYS.	INDEX	CENA NETTO
SZAFKI WISZĄCE			
	80,2x36x40	TS137/08	260 zł
	100,2x36x40	TS137/10	299 zł
	120,2x36x40	TS137/12	324 zł
	80,2x36x40	TS138/08*	757 zł
	100,2x36x40	TS138/10*	851 zł
	120,2x36x40	TS138/12*	978 zł
	80,2x36x40	TS139/08	391 zł
	100,2x36x40	TS139/10	433 zł
	120,2x36x40	TS139/12	478 zł
	80,2x36x76	TS140/08	548 zł
	100,2x36x76	TS140/10	641 zł
	120,2x36x76	TS140/12	706 zł

* drzwi szklane bez zamka

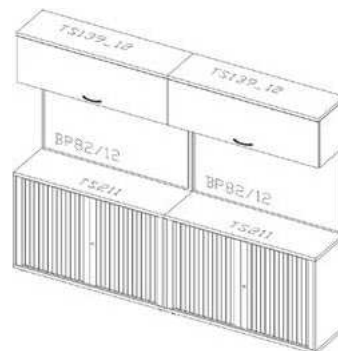
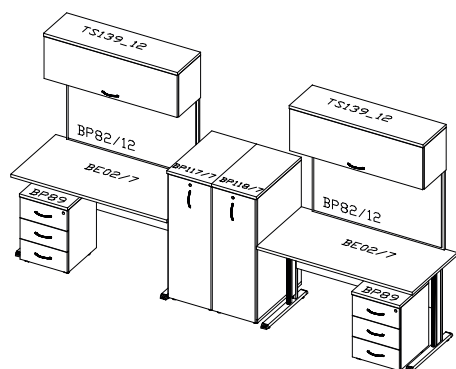

DOPLATY ZA PLECY Z PŁYTY 18 MM

wysokość szafy	6 OH (219,5)	5 OH (184,1)	4 OH (148,8)	3 OH (114,5)	2 OH (79,2)
szafa szer. 40,2	122 zł	100 zł	76 zł	67 zł	45 zł
szafa szer. 60,2	180 zł	150 zł	119 zł	100 zł	67 zł
szafa szer. 80,2	242 zł	199 zł	159 zł	133 zł	91 zł
szafa szer. 100,2	302 zł	246 zł	193 zł	165 zł	111 zł
szafa szer. 120,2	364 zł	298 zł	232 zł	199 zł	133 zł
szafa szer. 140,2	414 zł	347 zł	271 zł	232 zł	157 zł

RYСУNEK	WYMIARY SZER./GŁ./WYS.	INDEX	CENA NETTO
STOPKI METALOWE DO SZAF			
	4x4x12-13,5 do wysokości szaf należy dodać 9,5 cm	TS140SM	47 zł / szt.
	fi 4 x 12-13,5 do wysokości szaf należy dodać 9,5 cm	TS141SM	44 zł / szt.

RYСУNEK	WYMIARY SZER./GŁ./WYS.	INDEX	CENA NETTO
STOPKI PLASTIKOWE WPUSZCZANE DO SZAF			
	od wysokości szafy należy odjąć 2 cm	TS142SP	4 zł / szt.

DOPLATY ZA COKÓŁ DO SZAFY (z płyty)	
szer. 40,2 cm	68 zł
szer. 60,2 cm	74 zł
szer. 80,2 cm	83 zł
szer. 100,2 cm	95 zł
szer. 120,2 cm	104 zł
szer. 140,2 cm	112 zł

DOPLATY ZA USŁUGI DODATKOWE	
wycięcie otworu pod mediaport	50 zł/szt.
montaż przelotki u klienta	33 zł /szt.

DOPLATY ZA ZAMKI TYPU MASTER Z WYMIENNĄ WKŁADKĄ		
zamek baskwilowy	D1	105 zł
zamek kwadratowy zwykły (do drzwi uchylnych)	D2	39 zł
zamek do drzwi przesuwanych	D3	39 zł
zamek centralny do szuflad/kontenery	D46	53 zł
klucz matka	D5	92 zł
zamek szyfrowy mechaniczny	D6	209 zł

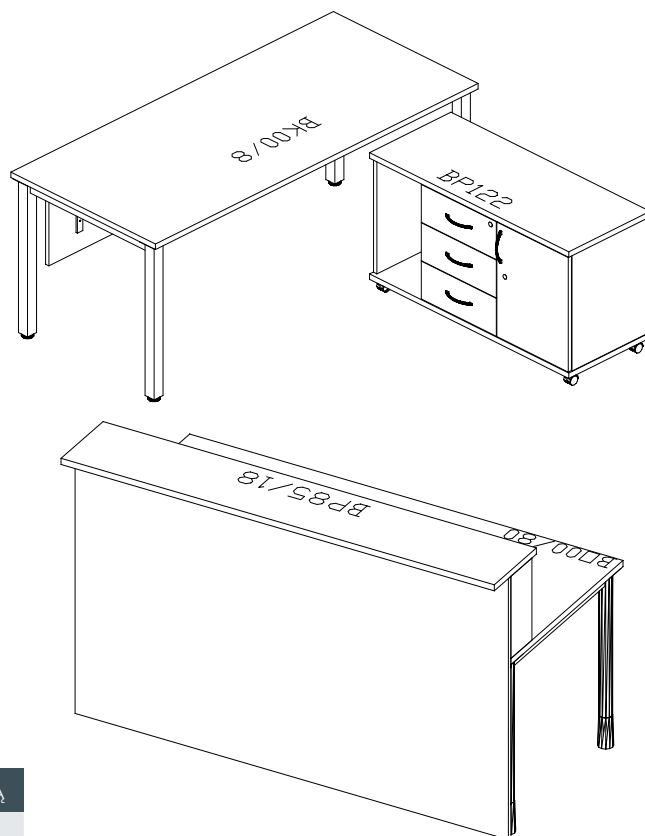

Meble wykonywane są z płyty wiórowej trzywarstwowej wg DIN68765 o gęstości 650-690 kg/m³ zgodnie z normą PN-EN14322 w klasie higieniczności E1.

BIURKA

- wykonane z płyty grubości 25 mm, wąskie krawędzie oklejone obrzeżem ABS o grubości 2 mm;
- stelaż stalowy, malowany proszkowo;

BP

- podstawa biurka z płyty laminowanej o grubości 18 mm, krawędzie oklejone obrzeżem ABS 1 mm,
- regulacja wysokości w zakresie 740-755 mm,
- blenda konstrukcyjna o wysokości 400 mm, połączona z nogami za pomocą złącz mimośrodowych i kołków drewnianych;
- w blendzie wyfrezowane dwa otwory na wyprowadzenie okablowania;

W biurkach kształtowych, wolnostojących zalecane jest zastosowanie dodatkowej nogi podpierającej BP48 lub BP49.

BE

- stelaż wykonany z nóg stalowych, malowanych proszkowo w kształcie litery „L”, z pionowym prowadzeniem okablowania;
- regulacja wysokości w zakresie 740-755 mm;
- nogi połączone blendą konstrukcyjną z płyty laminowanej o grubości 18 mm i wysokości 400 mm lub za dopłatą - kanałem metalowym skręcanym BP 59;
- w blendzie z płyty, wyfrezowane dwa otwory do prowadzenia okablowania;

W biurkach kształtowych wolnostojących zalecane jest zastosowanie dodatkowej nogi podpierającej BP48 lub BP49.

BO

- stelaż metalowy malowany proszkowo, wykonany z dwóch płotków z rury fi 50, połączonych ze sobą kształtownikiem stalowym 50x20 mm i belką skręcaną śrubami metrycznymi,
- nogi zakończone regulatorem z osłoną plastikową, regulacja w zakresie 710-790 mm;

W biurkach kształtowych wolnostojących zalecane jest zastosowanie dodatkowej nogi podpierającej BP48 lub BP49.

BK

- stelaż metalowy malowany proszkowo, wykonany z dwóch płotków z rury kwadratowej 50x50 mm, połączonych ze sobą kształtownikiem stalowym 50x20 mm i belką skręcaną śrubami metrycznymi,
- chromowany regulator wysokości, regulacja w zakresie 740-755 mm;

W biurkach kształtowych wolnostojących zalecane jest zastosowanie dodatkowej nogi podpierającej BP48 lub BP49.

BR

- biurko pojedyncze, z regulowanym elektrycznie stelażem, dwusilnikowe;
- noga o przekroju prostokątnym;
- zakres regulacji wysokości 650-1300 mm;
- szerokość podparcia blatu 600 mm;
- długość stopy 700 mm;
- maksymalny udźwig 120 kg;
- maksymalna prędkość 40 mm/s;
- poziom głośności <45 db;
- zintegrowany czujnik antykolizyjny;
- pilot z 4 pozycjami pamięci;

Dostępne kolory stelaży: aluminium RAL9006, biały RAL9010, czarny RAL9005.

- biurko podwójne, z regulowanym elektrycznie stelażem, dwusilnikowe;
- noga o przekroju prostokątnym;
- zakres regulacji wysokości 650-1300 mm;
- szerokość podparcia blatu 600 mm;
- długość stopy 700 mm;
- maksymalny udźwig 120 kg na każdy blat;
- maksymalna prędkość 40 mm/s;
- poziom głośności <45 db;
- zintegrowany czujnik antykolizyjny;
- pilot z 4 pozycjami pamięci;

Dostępne kolory stelaży: aluminium RAL9006, biały RAL9010, czarny RAL9005.

KONTENERY

- korpus, drzwi i półki wykonane z płyty laminowanej o grubości 18 mm, wieniec górny z płyty o grubości 25 mm;
- ścianka tylna z płyty laminowanej o grubości 18 mm, wpuszczona w nafrezowany korpus;
- krawędzie korpusu zabezpieczone okleiną ABS o grubości 1 mm, blaty i fronty - o grubości 2 mm;
- szuflady płytowe wyposażone w prowadnice rolkowe;
- szuflady metalowe (M) na zintegrowanych prowadnicach;
- szuflady zamykane zamkiem centralnym z kluczem łamanym, w wersji metalowej prostym.;
- drzwiczki zamykane na zamek z kluczem łamanym;
- w kontenerach mobilnych kółka obrotowe, w tym dwa kółka przednie z blokadą;
- w kontenerach stacjonarnych stopki regulowane w zakresie 740 – 755 mm;
- uchwyty metalowe 2 – punktowe o rozstawie 128 mm;
- dodatkowo szuflady mogą być wyposażone we wkładkę na przybory do pisania – piórnik BP 46;

SZAFY

- korpus, drzwi i półki szafy wykonane z płyty laminowanej o grubości 18 mm, wieniec górny i dolny z płyty o grubości 25 mm;
- krawędzie korpusu zabezpieczone okleiną ABS o grubości 1 mm, wieńce i fronty - o grubości 2 mm;
- korpus łączony na złącza mimośrodowe i kołki drewniane konstrukcyjne;
- drzwi osadzone na samodomykających zawiasach z cichym domykiem, o kącie rozwarcia min. 110 stopni, testowane na 40.000 cykli otwarcie – zamknięcie;
- uchwyty metalowe 2 – punktowe o rozstawie 128 mm;
- tylna ścianka wykonana z płyty HDF o grubości 3,2 mm, mocowana w nafrezowanych bokach i wieńcach szaf za pomocą złączy stabilizujących lub za dopłatą, ścianka tylna z płyty laminowanej o grubości 18 mm;
- w wieńcu dolnym stopki z regulacją wysokości od wewnątrz, w zakresie 15 mm;
- półki z możliwością regulacji na podpórkach uniemożliwiających przypadkowe wysunięcie;
- drzwi zamykane na zamek z kluczem łamanym;
- drzwi wyposażone w mechanizm blokujący drugie skrzydło szafy;
- nadstawki - wieniec dolny 18 mm;
- nadstawki- koniecznie mocować do ściany;

KOLORYSTYKA

Pełna kolorystyka znajduje się na wzorniku dekorów (dodatkowa wkładka).